

1 Description

These N-Channel enhancement mode power field effect transistors are produced using planar stripe, DMOS technology.

This advanced technology has been especially tailored to minimize on-state resistance, provide superior switching performance, and withstand high energy pulse in the avalanche and commutation mode. These devices are well suited for high efficiency switched mode power supplies, active power factor correction based on half bridge topology.

2 Features

- 600V / 3A , $R_{DS(on)} = 3.2\Omega$ (typ) @ $V_{GS} = 10V, I_D = 1.8A$
- Fast switching
- 100% avalanche tested
- Improved dv/dt capability..

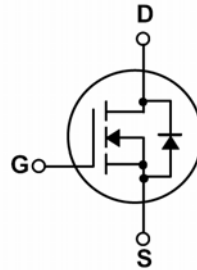
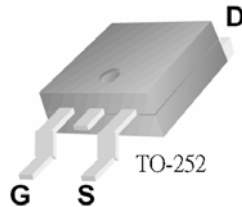

3 Absolute Maximum Ratings $T_C = 25^\circ C$ unless otherwise noted

Symbol	Parameter	apQ03SN60AB	Units
V_{DSS}	Drain-Source Voltage	600	V
I_D	Drain Current - Continuous ($T_C = 25^\circ C$)	3	A
I_{DM}	Drain Current – Pulsed ①	12	A
V_{GS}	Gate-Source Voltage	± 30	V
E_{AS}	Single Pulsed Avalanche Energy ②	200	mJ
I_{AR}	Avalanche Current	3.0	A
E_{AR}	Repetitive Avalanche Energy	7.5	mJ
dv/dt	Peak Diode Recovery dv/dt ③	4.5	V/ns
P_D	Power Dissipation ($T_C = 25^\circ C$) -De-rate above $25^\circ C$	75	W
		0.6	W/ $^\circ C$
T_J, T_{STG}	Operating and Storage Temperature Range	-55 to +150	$^\circ C$
T_L	Maximum lead temperature for soldering purposes, 1/8" from case for 5 seconds	300	$^\circ C$

* note :

- ① Repetitive Rating: Pulse width limited by maximum junction temperature.
- ② $V_{DD} = 50V$, starting $T_J = 25^\circ C$, $L = TBDD$, $R_G = 25\Omega$, $I_{AS} = 3A$
- ③ $I_{SD} \leq 3A$, $di/dt \leq 200A/\mu s$, $V_{DD} \leq V_{(BR)DSS}$, $T_J \leq 150^\circ C$.



DEVICE SPECIFICATION

apQ03SN60AB

600V/3A N-Channel MOSFET

4 Thermal Characteristics

Symbol	Parameter	apQ03SN60AB	Units
$R_{\theta JC}$	Thermal Resistance, Junction-to-Case	1.67	$^{\circ}\text{C/W}$
$R_{\theta CS}$	Thermal Resistance, Case-to-Sink Typ.	40	$^{\circ}\text{C/W}$
$R_{\theta JA}$	Thermal Resistance, Junction-to-Ambient	62.4	$^{\circ}\text{C/W}$

5 Electrical Characteristics $T_C = 25^{\circ}\text{C}$ unless otherwise noted

Symbol	Parameter	Test Conditions	Min	Typ	Max	Units
Off Characteristics						
BV_{DSS}	Drain-Source Breakdown Voltage	$V_{GS} = 0\text{ V}, I_D = 250\ \mu\text{A}$	600	--	--	V
$\Delta BV_{DSS} / \Delta T_J$	Breakdown Voltage Temperature Coefficient	$I_D = 250\ \mu\text{A}$, Referenced to 25°C	--	0.6	--	$\text{V}/^{\circ}\text{C}$
I_{DSS}	Gate to Source leakage current	$V_{DS} = 600\text{ V}, V_{GS} = 0\text{ V}$	--	--	20	μA
I_{GSSF}	Gate-Body Leakage Current, Forward	$V_{GS} = 30\text{ V}, V_{DS} = 0\text{ V}$	--	--	100	nA
I_{GSSR}	Gate-Body Leakage Current, Reverse	$V_{GS} = -30\text{ V}, V_{DS} = 0\text{ V}$	--	--	-100	nA
On Characteristics						
$V_{GS(th)}$	Gate Threshold Voltage	$V_{DS} = V_{GS}, I_D = 250\ \mu\text{A}$	2.0	--	4.0	V
$R_{DS(on)}$	Static Drain-Source On-Resistance	$V_{GS} = 10\text{ V}, I_D = 1.8\text{ A}$ ④	--	3.2	3.8	Ω
g_{FS}	Forward Transconductance	$V_{DS} = 15\text{ V}, I_D = 1.5\text{ A}$ ①	--	--	10	S
Dynamic Characteristics						
C_{iss}	Input Capacitance	$V_{DS} = 25\text{ V}, V_{GS} = 0\text{ V}, f = 1.0\text{ MHz}$	--	352	--	pF
C_{oss}	Output Capacitance		--	48	--	pF
C_{rss}	Reverse Transfer Capacitance		--	5.6	--	pF
Switching Characteristics						
$t_{d(on)}$	Turn-On Delay Time	$V_{DD} = 300\text{ V}, I_D = 3\text{ A}, R_G = 10\ \Omega, R_D = 150\ \Omega, V_{GS} = 10\text{ V}$ ④	--	9.0	--	ns
t_r	Turn-On Rise Time		--	28	--	ns
$t_{d(off)}$	Turn-Off Delay Time		--	21	--	ns
t_f	Turn-Off Fall Time		--	29	--	ns
Q_g	Total Gate Charge	$V_{DS} = 480\text{ V}, I_D = 3\text{ A}, V_{GS} = 10\text{ V}$ ④	--	9.7	--	nC
Q_{gs}	Gate-Source Charge		--	3.0	--	nC
Q_{gd}	Gate-Drain Charge		--	5.0	--	nC
Drain-Source Diode Characteristics and Maximum Ratings						
I_S	Maximum Continuous Drain-Source Diode Forward Current		--	--	3	A
I_{SM}	Maximum Pulsed Drain-Source Diode Forward Current		--	--	12	A
V_{SD}	Drain-Source Diode Forward Voltage	$V_{GS} = 0\text{ V}, I_S = 1.5\text{ A}$	--	--	1.5	V

t_{rr}	Reverse Recovery Time	$V_{GS} = 0\text{ V}, I_F = 3\text{ A},$ $di_F/dt = 100\text{ A}/\mu\text{s}$ ④	--	210	--	ns
Q_{rr}	Reverse Recovery Charge		--	1.2	--	μC

Notes:

- ① Repetitive Rating: Pulse width limited by maximum junction temperature.
- ② $V_{DD} = 50\text{ V}$, starting $T_J = 25^\circ\text{C}$, $L = \text{TBD}$, $R_G = 25\Omega$, $I_{AS} = 3\text{ A}$
- ③ $I_{SD} \leq 3\text{ A}$, $di/dt \leq 200\text{ A}/\mu\text{s}$, $V_{DD} \leq V_{(BR)DSS}$, $T_J \leq 150^\circ\text{C}$
- ④ Pulse Test: Pulse width $\leq 300\mu\text{s}$, Duty cycle $\leq 2\%$.

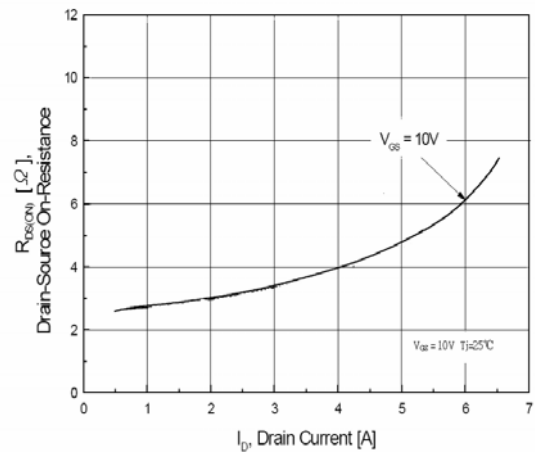
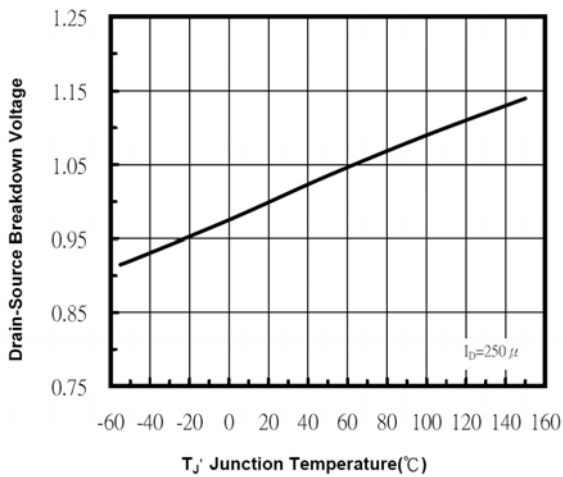
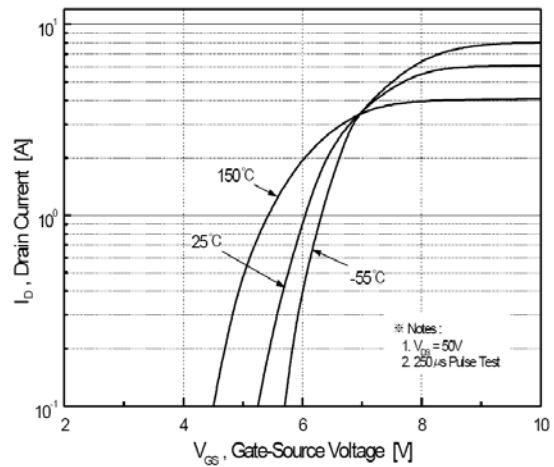
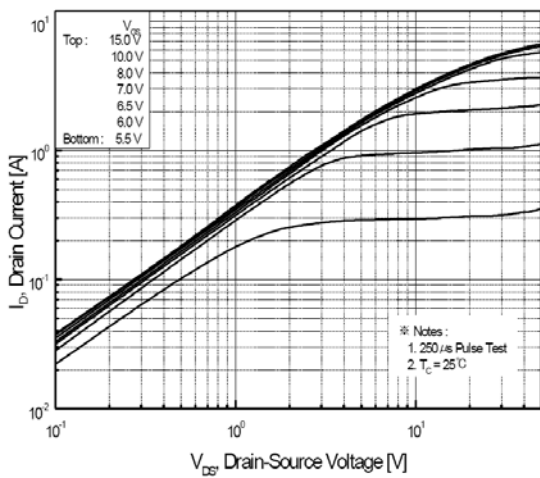

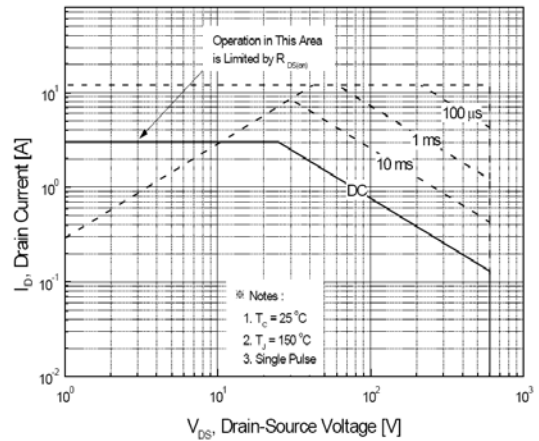
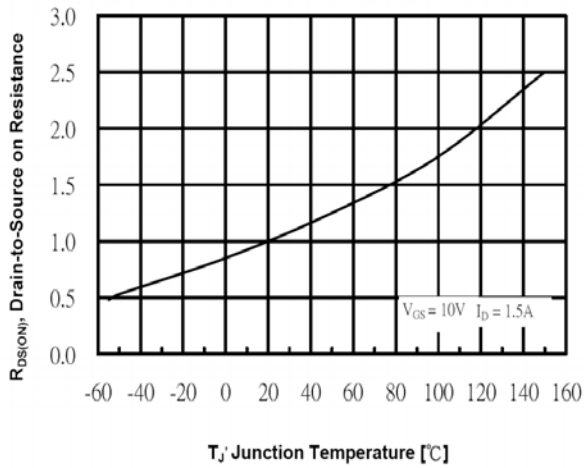
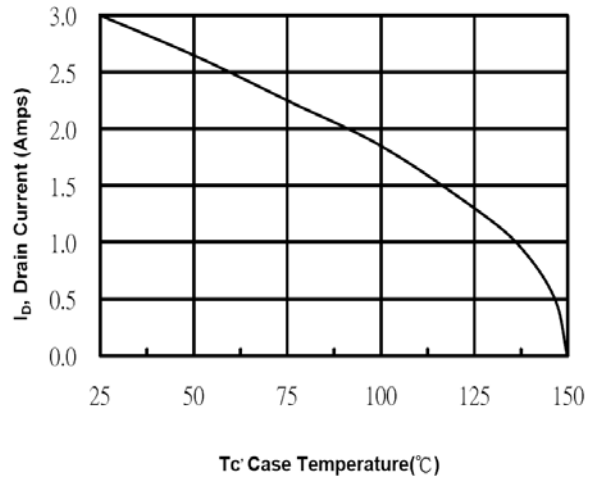
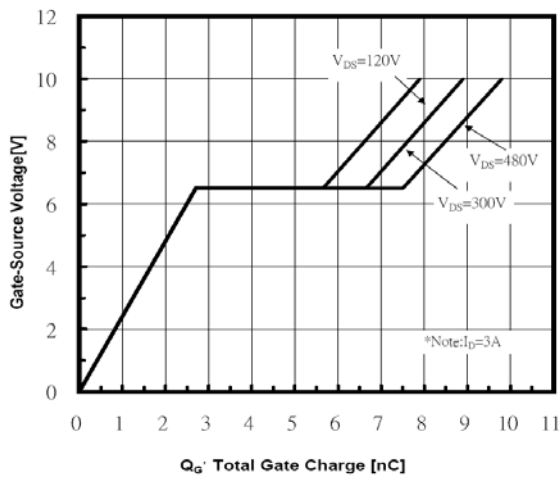
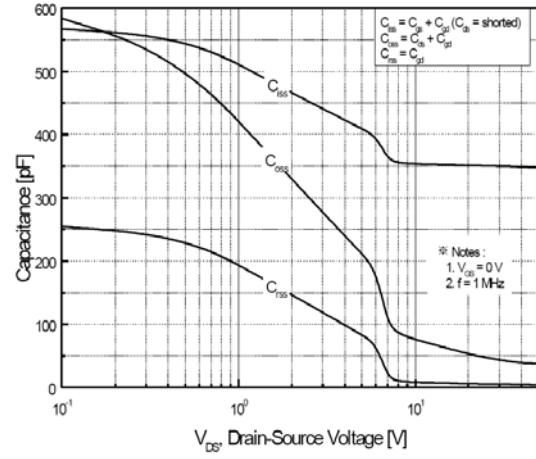
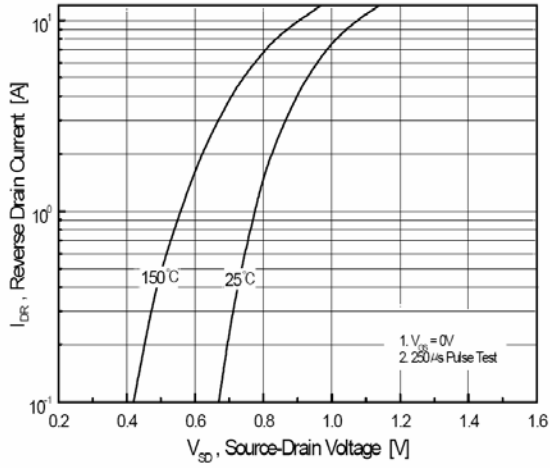

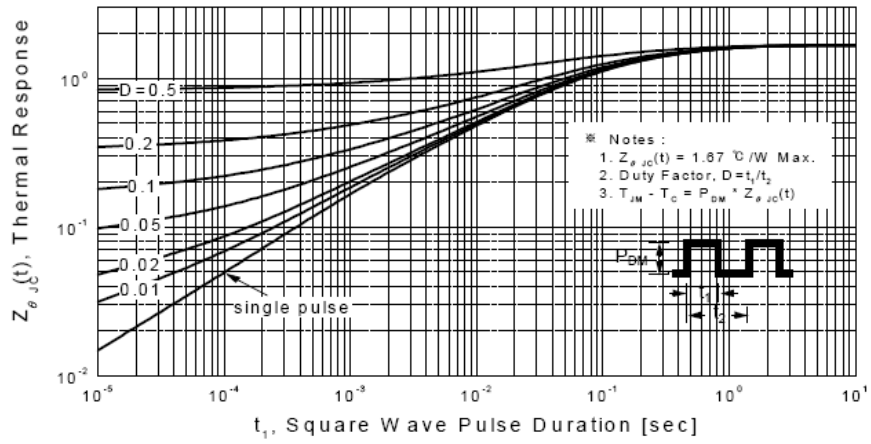

6 Package Dimensions

TO-252

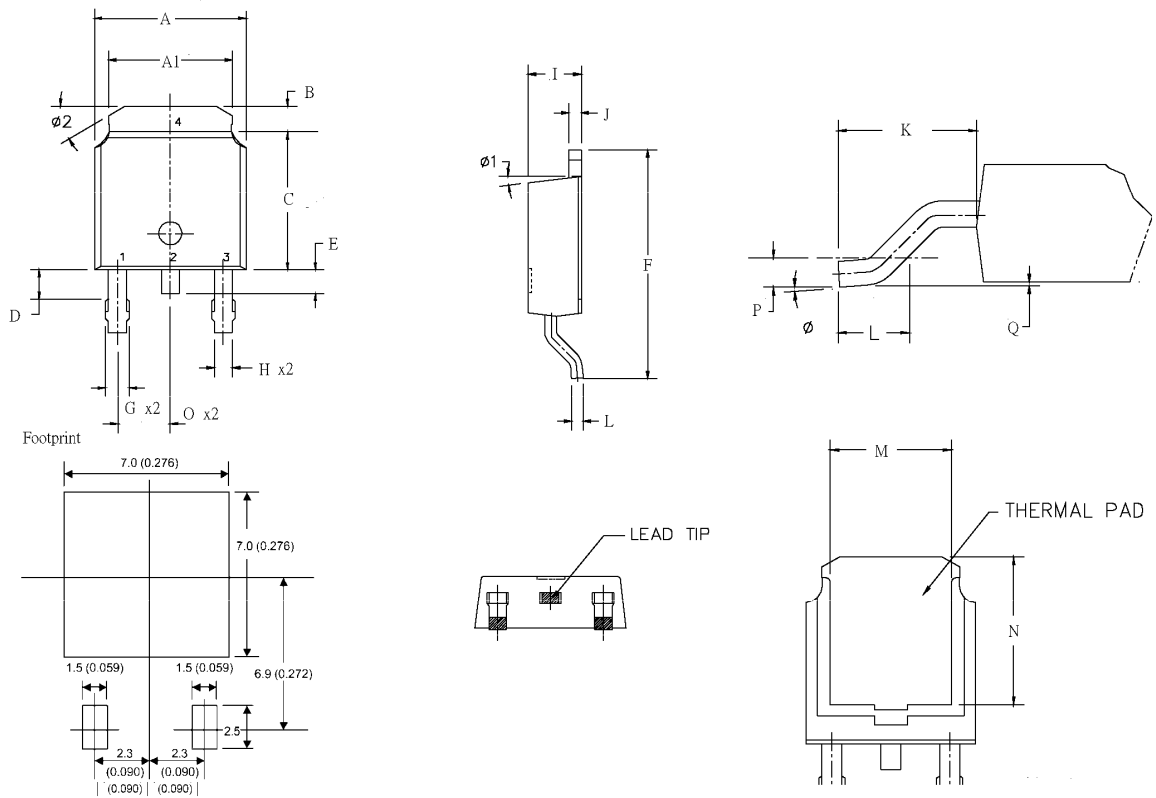

TO-252 DIMENSION							
DIM	MILLIMETERS						
	MIN	MAX	TYP.	DIM	MIN	MAX	TYP.
A	6.35	6.73	6.57	J	0.46	0.89	0.68
A1	4.95	5.46	5.21	K	0°	10°	5°
B	0.89	1.27	1.08	L	0.46	1.78	0.54
C	5.97	6.22	6.10	M	4.32	--	--
D	25°	35°	30°	N	5.21	--	--
E	0.64	1.02	0.83	O	2.29 BSC		
F	9.40	10.41	9.91	P	0.51 BSC		
G	0.76	1.14	0.95	Q	--	0.13	--
H	0.64	0.89	0.77	R	0°	10°	5°
I	2.18	2.39	2.29	S	2.29	2.79	2.54



DEVICE SPECIFICATION

apQ03SN60AB

600V/3A N-Channel MOSFET

Note

The declared data are only a description of product, information furnished is believed to be accurate and reliable. However, alpha pacific assumes no responsibility for the consequences of use of such information nor for any infringement of patents or other rights of third parties which may result from its use. No license is granted by implication or otherwise under any patent or patent rights of alpha pacific. alpha pacific reserves the right to make changes on this specification without notice at any time.

This publication supersedes and replaces all information previously supplied. All alpha pacific products are not authorized for use as critical components in life support devices or systems, except by a written approval of alpha pacific.

Reprinting this data sheet - or parts of it - is only allowed with a license of alpha pacific.

contact

alpha pacific Technologies Co., Ltd
3F-6, No.18, Lane 609, Sec.5
Chung Sin road, Shan Chang City
Taipei-Hsien, TAIWAN, R.O.C

tel +886-2-2999 5456
fax +886-2-2999 5270
internet www.alpha-pacific.com